

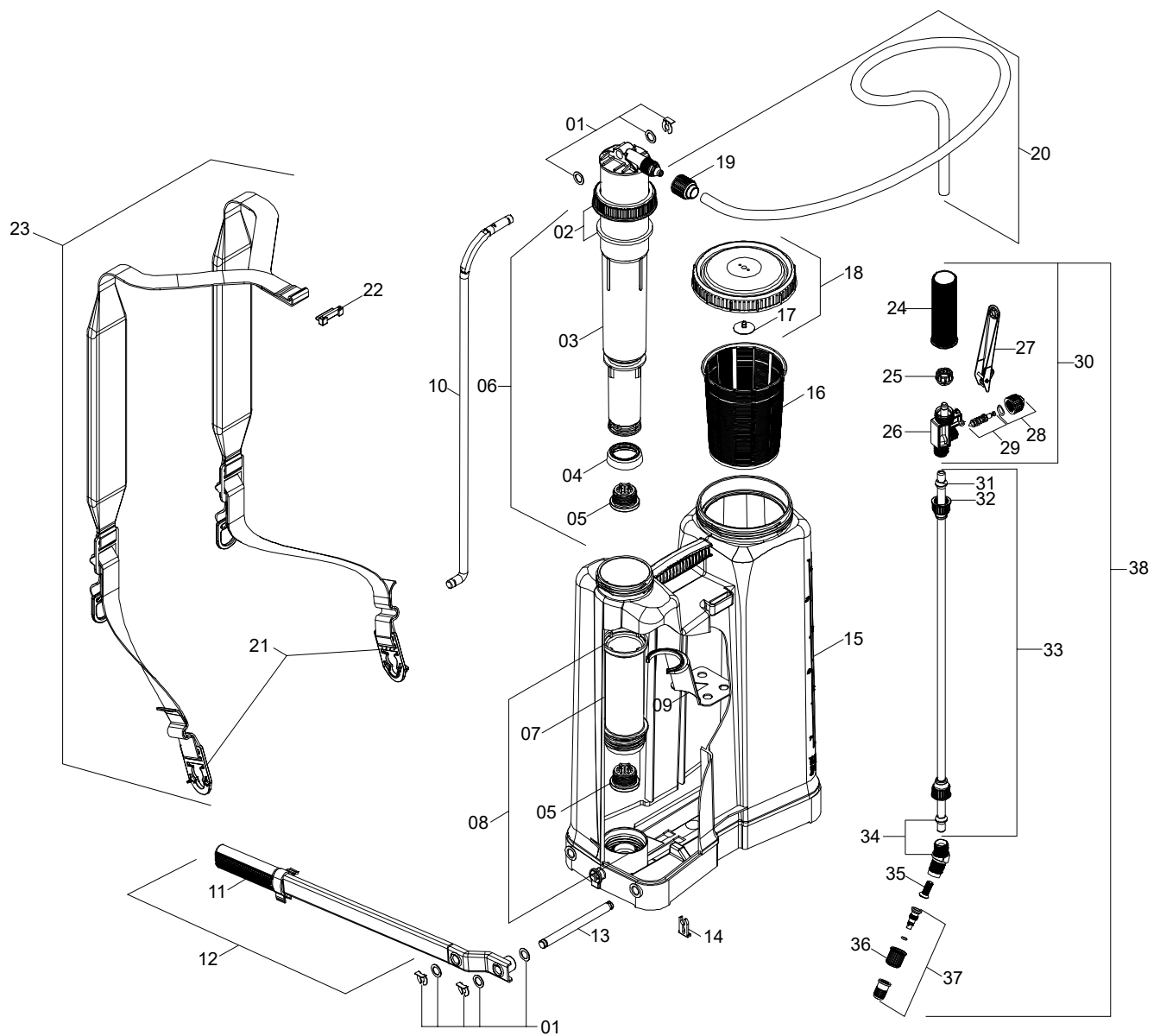

































PARTS CATALOG

JACTO HD-400U



Nº	CODE	DESCRIPTION	IMAGE	QTY.	UTILIZATION	NCM HS CODE	EAN BARCODE
1	1198800	WASHERS AND LOCKED RINGS SET		1	PJ, PJH, XP, HD	7318.22.00	7909436961189
2	907121	GASKET HOLDER AND GASKET HD		1	HD	3926.90.90	7899144843856
3	1278245	CHAMBER BODY AND PISTON CUP U		1	HD-U	8424.90.90	7909436956789
4	1247522	PISTON CUP Ø45 X 12		1	HD-U	4016.93.00	7909436932356
5	1173630	FASTENER WITH SPHERE		1	HD	8424.90.90	7899144894414
6	1247519	HD-U CHAMBER ASSEMBLY		1	HD-U	8424.90.90	7909436906081
7	635599	CYLINDER BODY HD		1	HD	8424.90.90	7896821558348
8	277368	CYLINDER ASSEMBLY WITHOUT VALVE		1	HD	8424.90.90	7896821546468
9	214619	HD AGITATOR		1	HD	8424.90.90	7896821546802
10	1197400	ROD WITH LOCK		1	PJ, PJH, XP, HD	8424.90.90	7896660836980
11	495812	HANDGRIP WITH LOCK		1	PJ, PJH, XP, HD	8424.90.90	7896821573990
12	615005	PUMPING LEVER		1	PJ, PJH, XP, HD	8424.90.90	7896821509753
13	293324	LEVER SHAFT		1	XP, HD	7318.24.00	7896821509753
14	277350	SHAFT LOCK		1	XP, HD	8424.90.90	7896821567326
15	NA	HD-400U COMPLETE TANK		1	HD-400U	8424.90.90	7909436946872
16	1220919	TANK STRAINER		1	PJ, HD, PJB, DJB	8424.90.90	7896660888309
17	1280174	LID DIAPHRAGM U		1	PJ-U, HD-U, PJB-U	4016.99.90	7909436956420

JACTO HD-400U

Nº	CODE	DESCRIPTION	IMAGE	QTY.	UTILIZATION	NCM HS CODE	EAN BARCODE
18	1247526	LID AND DIAPHRAGM U		1	PJ-U, HD-U, PJB-U	8424.90.90	7909436906227
19	942193	SCREW CAP S20 X 1,5		1	PJH, PJ, XP, HD, PJB, DJB, DJB-S	3926.90.90	7896821551912
20	1247524	JACTO HD-U HOSE		1	HD-U	8424.90.90	7909436906210
21	1220973	HD BUCKLE		1	HD, PJB, DJB, DJB-S	8424.90.90	7909436915274
22	1222671	STRAP LOCK		1	HD	8424.90.90	7909436914642
23	1256384	PADDED STRAP BELT WITH ADJUSTMENT HD-400		1	HD-400	8424.90.90	7909436922777
24	1220962	TRIGGER VALVE HANDLE LP		1	PJH, PJ, HD, PJB, DJB	8424.90.90	7909436924115
25	1220966	CLIP LP 601		1	PJH, PJ, HD, PJB, DJB	3926.90.90	7909436924474
26	1220968	TRIGGER VALVE BODY LP 601		1	PJH, PJ, HD, PJB, DJB	8481.90.90	7909436924603
27	1220951	TRIGGER VALVE LEVER LP 601 P		1	PJH, PJ, HD, PJB, DJB	8424.90.90	7909436923989
28	1247527	TRIGGER VALVE CAP LP 601/ 605 AND SEAL U		1	PJ-U, HD-U, PJB-U	8481.90.90	7909436906296
29	1278246	TRIGGER VALVE NEEDLE U		1	PJ-U, HD-U, PJB-U	8424.90.90	7909436962421
30	1278225	TRIGGER VALVE LP 601 U		1	PJ-U, HD-U, PJB-U	8424.90.90	7909436946889
31	1220972	CONE PACKING		1	PJH, PJ, XP, HD, PJB, DJB, DJB-S	3926.90.90	7909436925037
32	1220969	SCREW CAP 11/16		1	PJH, PJ, XP, HD, PJB, DJB, DJB-S	3926.90.90	7909436924924
33	100131	STAINLESS STEEL LANCE		1	PJH, PJ, XP, HD, PJB, DJB	8424.90.90	7896821501252
34	635276	JOINT AND CONE PACKING		1	PJH, PJ, XP, HD, PJB, DJB, DJB-S	3917.40.90	7909436931311

Nº	CODE	DESCRIPTION	IMAGE	QTY.	UTILIZATION	NCM HS CODE	EAN BARCODE
35	1168545	NOZZLE FILTER M50/60		1	PJH, PJ, XP, HD, PJB, DJB, DJB-S	8424.90.90	7896660860053
36	1168546	NOZZLE CAP		1	PJH, PJ, XP, HD, PJB, DJB, DJB-S	8424.90.90	7909436925310
37	1222664	BLUE ADJUSTABLE CONE NOZZLE		1	PJH, PJ, XP, HD, PJB, DJB	8424.90.90	7909436928588
38	1247523	LANCE AND TRIGGER VALVE U		1	PJ-U, HD-U, PJB-U	8424.90.90	7909436906104